

Anti-glare diffuser of LED high bay

Instruction Manual

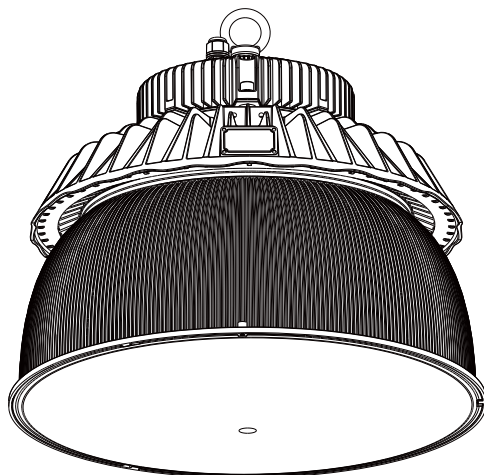

Installation Manual for Anti-glare diffuser of LED high bay.

A. Physical Dimensions (Unit:mm)

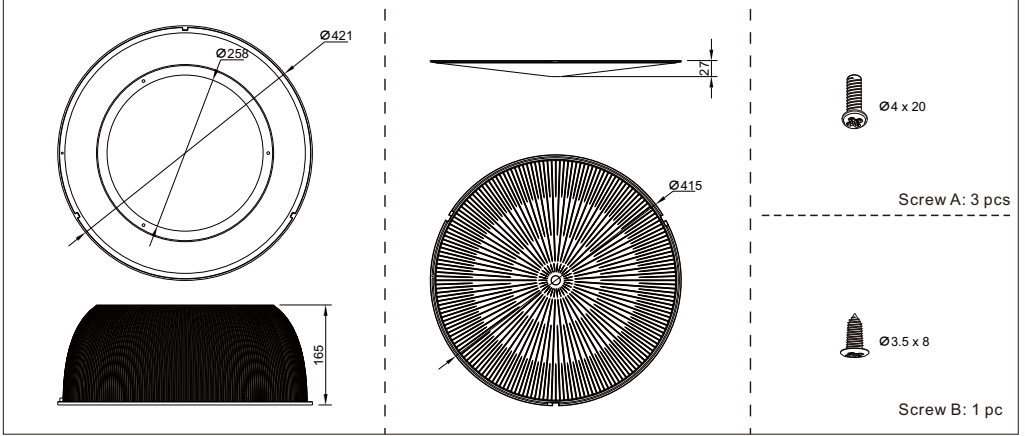

B. Installation Instruction

1. 

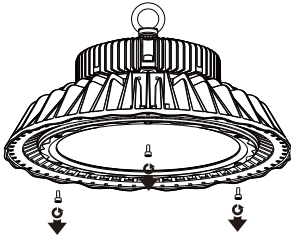

Take 3 screws off, keep the other 3.

2. 

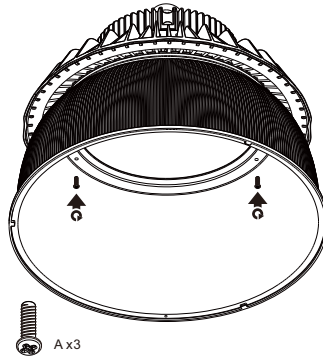

Install the Anti-glare diffuser body to LED high bay with 3 supplied screws.

3. 

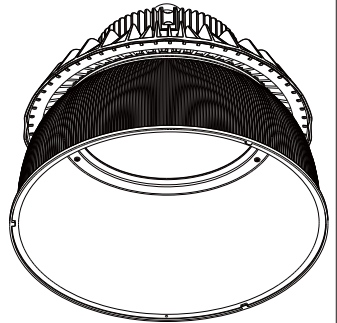

4. 

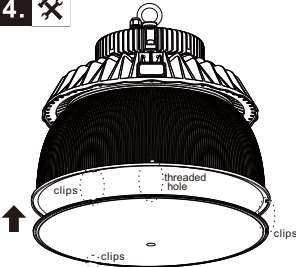

Put the clips and threaded hole to matching positions.

5. 

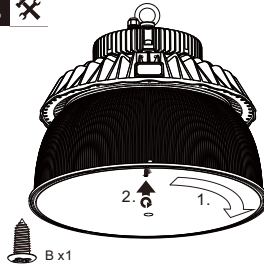

Push the cover in clockwise direction to make the clips locked tight, fasten the diffuser body and cover with the supplied screw.

6. 

